

50mA and 150mA CMOS Linear Regulators

FEATURES

- Very low Dropout Voltage: 200mV typ (150mA load)
- High Output Setpoint Accuracy of 2%
- Very low Input Voltages Down to 1.6V
- Power-saving Shutdown Mode of 150nA (typ)
- Fast Turn-on (90µs) and Turn-off (90µs)
- Extremely low Quiescent Current of 14µA (typ)
- Very Tight Line regulation, 0.2%/V
- Load Regulation 0.125 mV/mA
- Thermal Shutdown Protection
- Low Noise Output, 100µVRMS With 10nF Bypass
- Fixed or Adjustable Output Versions Available
- Available in RoHS Compliant, Lead Free Packages: SC70 and SOT23

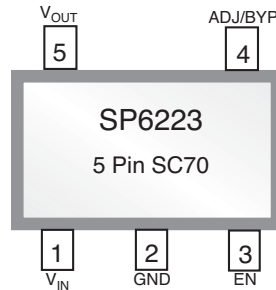

APPLICATIONS

- Cellular Telephones
- Laptop, Notebooks and Palmtop Computers
- Battery-Powered Equipment
- Consumer/ Personal Electronics
- SMPS Post-Regulator
- DC-to-DC Modules
- Medical Devices
- Data Cable
- Pagers

DESCRIPTION

The SP6222 and SP6223 are CMOS LDOs designed to meet a broad range of applications that require accuracy, speed and ease of use. These LDOs offer extremely low quiescent current which only increases slightly under load, thus providing advantages in ground current performance over bipolar LDOs. The LDOs handle an extremely wide load range and guarantee stability with a 1µF ceramic output capacitor. They have excellent low frequency PSRR, not found in other CMOS LDOs and thus offer exceptional Line Regulation. High frequency PSRR is 55dB (typical) at 1kHz. Load Regulation is excellent and temperature stability is comparable to bipolar LDOs. An enable feature is provided on all versions. The SP6222/6223 is available in fixed and adjustable output voltage versions in industry standard SC70 and SOT23 packages.

TYPICAL APPLICATION CIRCUIT

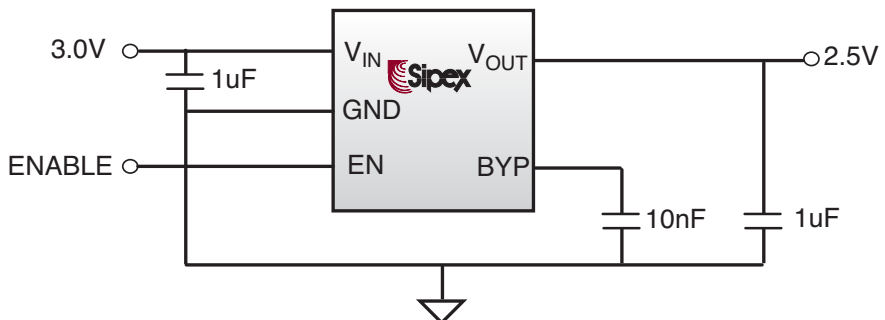

ABSOLUTE MAXIMUM RATINGS

These are stress ratings only and functional operation of the device at these ratings or any other above those indicated in the operation sections of the specifications below is not implied. Exposure to absolute maximum rating conditions for extended periods of time may affect reliability.

Supply Input Voltage (V_{IN})	-2V to 6V	Storage Temperature.....	-65°C to +150°C
Output Voltage (V_{OUT})	-0.6V to $V_{IN}+1V$	Junction Temperature (T_J).....	-40°C to +125°C
Enable Input Voltage (V_{EN})	-2V to 7V	Lead Temperature (soldering 5s).....	300°C
Power Dissipation (P_D)	Internally Limited, Note 1		

ELECTRICAL CHARACTERISTICS

Unless otherwise specified: $V_{IN} = V_{OUT} + 0.3V$ to 4.5V, $C_{OUT} = 1\mu F$ ceramic, $C_{IN} = 1\mu F$ ceramic, $I_{OUT} = 100\mu A$, $T_A = 25^\circ C$.
Bold values apply over the full operating temperature range (-40°C to 125°C).

PARAMETER	MIN	TYP	MAX	UNITS	CONDITIONS
Operating Input Voltage Range Note 2	1.6		4.5	V	$I_{OUT} = 50mA$ (SP6222) $I_{OUT} = 150mA$ (SP6223)
Output Voltage Accuracy		-	2 3	%	
Fixed Output Voltage (3.0V version)	2.91	3.0	3.09	V	
Fixed Output Voltage (2.5V version)	2.425	2.500	2.575	V	
Reference Voltage	0.873	0.9	0.927	V	Adjustable version only
Line Regulation		0.05	0.2	%/V	ΔV_{OUT} (V_{IN} below 4.5V)
Load Regulation		0.125	0.225	mV/mA	$I_{OUT} = 0.1mA$ to 50mA (SP6222) $I_{OUT} = 0.1mA$ to 150mA (SP6223)
Thermal Regulation		0.005		%/°C	$I_{OUT} = 50mA$ (SP6222)
Dropout Voltage (DOV), Note 3		60 200	100 300	mV	$I_{OUT} = 50mA$ (SP6222) $I_{OUT} = 150mA$ (SP6223)
Ground Pin Current		14	25	μA	$I_{OUT} = 0.1mA$

Note 1. The maximum allowable power dissipation at any T_A (ambient temperature) is $P_{D(MAX)} = (T_{J(MAX)} - T_A) / \theta_{JA}$. Exceeding the maximum allowable power dissipation will result in excessive die temperature, and the regulator will go into thermal shutdown. The θ_{JA} of the SP6222/23 (SC-70-5) is 330°C/W mounted on a PC board with minimum copper area (see “Thermal Considerations” section for further details).

Note 2. Minimum V_{IN} must meet 2 conditions: $V_{IN} > 1.6V$ and $V_{IN} \geq \{V_{OUT} + DOV\}$

Note 3. Dropout Voltage DOV is defined as the input to output differential at which the output voltage drops 2% below its nominal value measured at 1V differential. The DOV specification is not applicable to output voltages less than 2.7V.

ELECTRICAL CHARACTERISTICS

Unless otherwise specified: $V_{IN} = V_{OUT} + 0.3V$ to 4.5V, $C_{OUT} = 1\mu F$ ceramic, $C_{IN} = 1\mu F$ ceramic, $I_{OUT} = 100\mu A$, $T_A = 25^\circ C$.
Bold values apply over the full operating temperature range (-40°C to 125°C).

PARAMETER	MIN	TYP	MAX	Units	CONDITIONS
Shutdown Supply Current @ 25°C		0.150	1	μA	$V_{EN} < 0.4V$ (shutdown), $V_{SUPPLY} = 1.6V$
Shutdown Supply Current @ 125°C			5	μA	$V_{EN} < 0.4V$ (shutdown), $V_{SUPPLY} = 1.6V$
Thermal Shutdown Die Temperature	125	150	175	°C	Regulator turns off
Thermal Shutdown Hysteresis		15		°C	Regulator turns on again @ 150°C
Power Supply Rejection Ratio		-55		dB	$f \leq 1kHz$
Output Noise Voltage		800		μV_{RMS}	$I_{OUT} = 0.1mA$, $C_{BYP} = 0nF$, $V_{OUT} = 3.0V$
		550			$I_{OUT} = 50mA$, $C_{BYP} = 0nF$, $V_{OUT} = 3.0V$
		150			$I_{OUT} = 0.1mA$, $C_{BYP} = 10nF$, $V_{OUT} = 3.0V$
		100			$I_{OUT} = 50mA$, $C_{BYP} = 10nF$, $V_{OUT} = 3.0V$
Wake-up time (T_{ON}) from Shutdown		90	200	μs	$V_{IN} \geq 1.6V$, $I_{OUT} = 30mA$
Turn-off time (T_{OFF}) into Shutdown		90	140	μs	$I_{OUT} = 0.1mA$, $V_{IN} \geq 1.6V$
Enable input logic low voltage			0.4	V	Regulator shutdown
Enable input logic high voltage	1.6			V	Regulator enabled

PIN DESCRIPTION

Pin Name	Pin Number		Description
	5 pin SC-70	5 pin SOT23	
V_{IN}	1	1	Power supply input. Connect a 1uF decoupling capacitor next to this pin.
GND	2	2	Ground Pin.
EN	3	3	Enable/Shutdown (Logic high = enable, logic low = shutdown)
BYP	4 (Fixed)	4 (Fixed)	Reference bypass input for ultra-quiet operation. Connecting 10nF capacitor from this pin to ground reduces output noise
ADJ	4 (Adjustable)	4 (Adjustable)	Adjustable regulator feedback input. Connect to a resistive voltage-divider network.
V_{OUT}	5	5	Output voltage of the linear regulator. Connect a 1uF or larger capacitor from this pin to ground.

General Overview

The SP6222 and SP6223 are CMOS LDOs designed to meet a broad range of low voltage applications that require accuracy and ease of use. The SP6222 offers a 50mA output current while the SP6223 offers an output current of 150mA. The SP6222 is available in a 2.5V or 3.0V fixed output along with an adjustable output version. The SP6223 is offered in an adjustable output only. These LDOs have a minimum input voltage of only 1.6V and a maximum input voltage of 4.5V. The output voltage can be programmed to as low as 0.9V and have a maximum dropout voltage rating of 100mV for the SP6222 and 300mV for the SP6223. Both devices are equipped with an enable (EN) input for very low current (10nA typical) shutdown mode.

Enable / Shutdown Operation

The SP6222/6223 is turned on by providing 1.6V or greater to the EN pin. To place the device into shutdown pull the EN pin below 0.4V. If this feature is not required connect EN to input supply to always enable the device whenever power is applied.

Input / Output Capacitor

The SP6222/6223 is designed to operate using very small ceramic capacitors. The minimum input and output capacitor value for stable operation is 1.0 μ F. The output capacitor value may be increased without limit to improve transient response. Place these capacitors as close as possible to the device.

Bypass (BYP) Capacitor

The fixed output versions offer a BYP pin to decouple the bandgap reference. Connecting an external 10nF capacitor from BYP to GND can reduce output noise. If output noise is not a concern the BYP pin may be left open. When a bypass capacitor is used the turn on time is slower. See the following turn on time plots for various BYP capacitor values. The adjustable output version does not offer this BYP input.

Adjustable Regulator

The output of the device can be programmed to a specific voltage by using two external resistors connected to the ADJ pin (see Typical Application Circuit for Adjustable output). The resistors set

the output voltage based on the following equation:

$$V_{OUT} = V_{REF} * (R1/R2 + 1)$$

Resistor values are not critical because the ADJ (adjust) pin has a high impedance, but for best performance use resistor values of 470K Ω or less.

Thermal Considerations

The SP6222/6223 is designed to provide 50mA -150mA of continuous current in a tiny package. Maximum power dissipation can be calculated based on the output current and the voltage drop across the part. To determine the maximum power dissipation of the package, use the junction-to-ambient thermal resistance of the device and the following equation:

$$P_{D(MAX)} = (T_{J(max)} - T_A) / \theta_{JA}$$

$T_{J(max)}$ is the maximum junction temperature of the die and is 125°C. T_A is the ambient temperature. θ_{JA} is the junction-to-ambient thermal resistance of the package. The SOT-23 package has a θ_{JA} of approximately 191°C/W and the SC70 package has a θ_{JA} of approximately 330°C/W.

The actual power dissipation of the regulator circuit can be determined by using the simplified equation:

$$P_D = (V_{IN} - V_{OUT}) * I_{OUT}$$

To prevent the device from entering thermal shutdown, maximum power dissipation cannot be exceeded.

Layout Considerations

The primary path of heat conduction out of the package is via the package leads. Therefore, careful consideration must be taken into account for optimizing layout.

1. Attaching the part to a large copper footprint will enable better heat transfer from the device, especially where there are internal ground and power planes.
2. Place the input and output capacitors close to the device for optimal transient response and device behavior.
3. Connect all ground connections directly to the ground plane. In case there is no ground plane, connect to a common ground point before connecting to board ground.

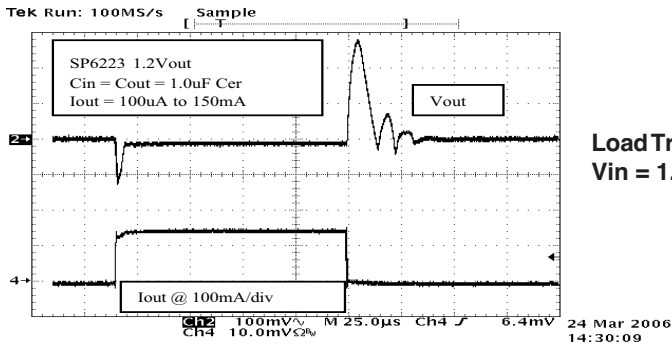

Load Transient Response, 100 μ A to 150mA,
Vin = 1.6V

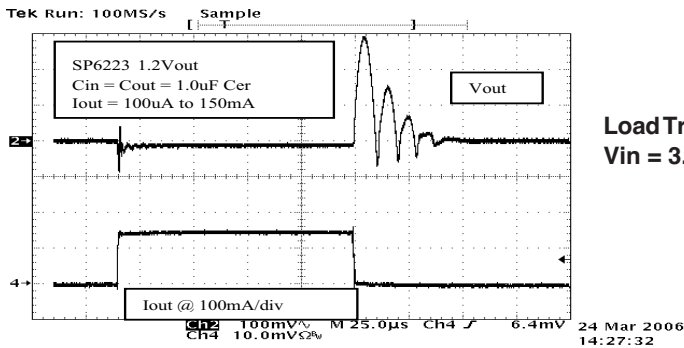

Load Transient Response, 100 μ A to 150mA,
Vin = 3.3V

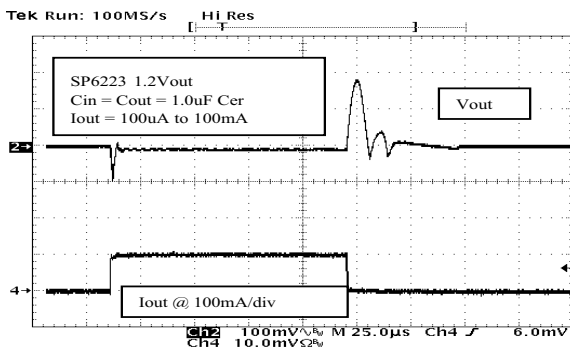

Load Transient Response, 100 μ A to 100mA,
Vin = 1.6V

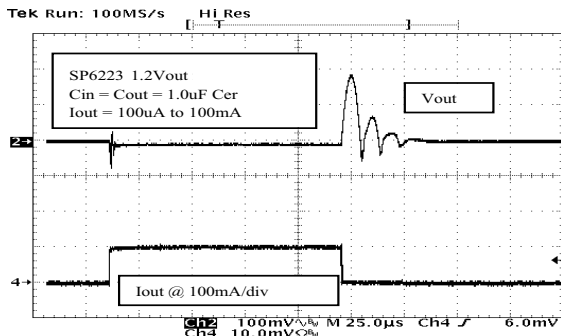

Load Transient Response, 100 μ A to 100mA,
Vin = 3.3V

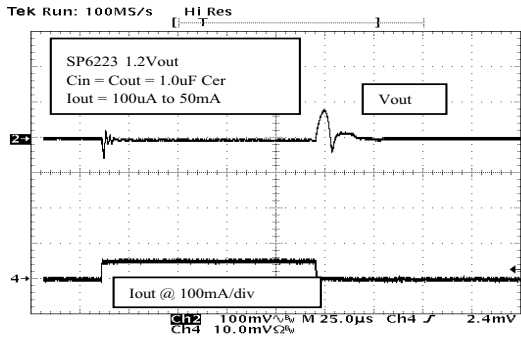

Load Transient Response, 100µA to 50mA, Vin = 1.6V

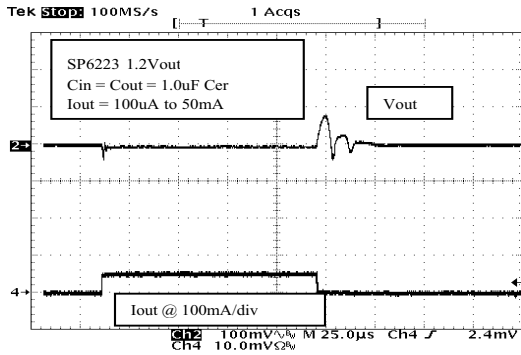

Load Transient Response, 100µA to 50mA, Vin = 3.3V

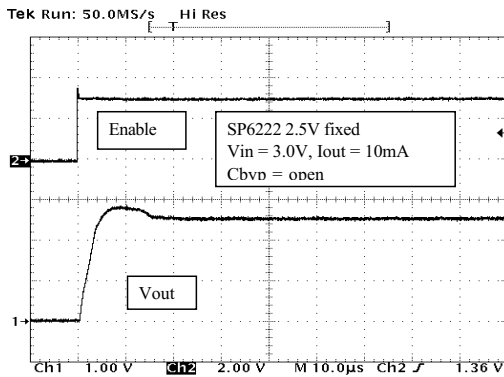

Turn on time, Vin = 3.0V, Iout = 10mA, CBYP = Open

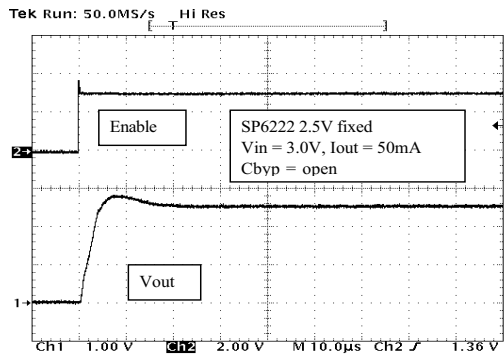

Turn on time, Vin = 3.0V, Iout = 50mA, CBYP = Open

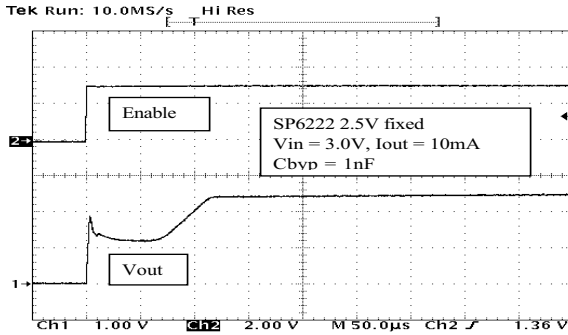

Turn on time, $V_{in} = 3.0V$, $I_{out} = 10mA$, $CBYP = 1nF$

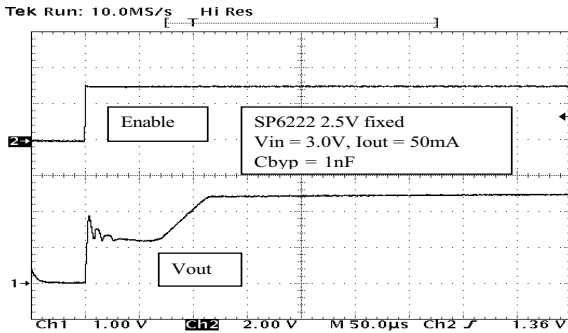

Turn on time, $V_{in} = 3.0V$, $I_{out} = 50mA$, $CBYP = 1nF$

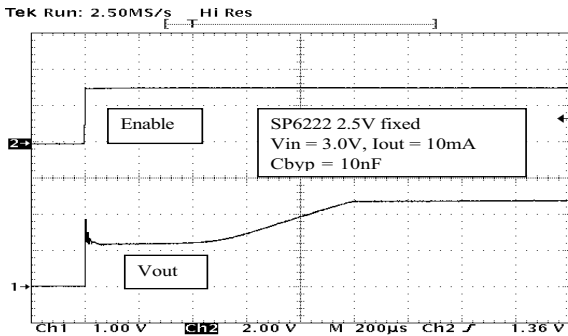

Turn on time, $V_{in} = 3.0V$, $I_{out} = 10mA$, $CBYP = 10nF$

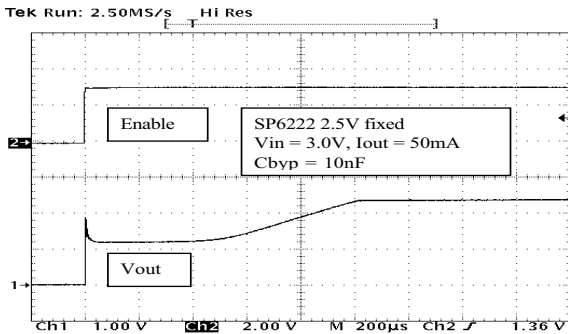

Turn on time, $V_{in} = 3.0V$, $I_{out} = 50mA$, $CBYP = 10nF$

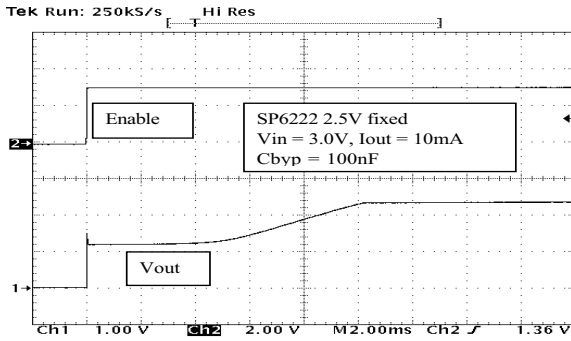

Turn on time, Vin = 3.0V, Iout = 10mA, CBYP = 100nF

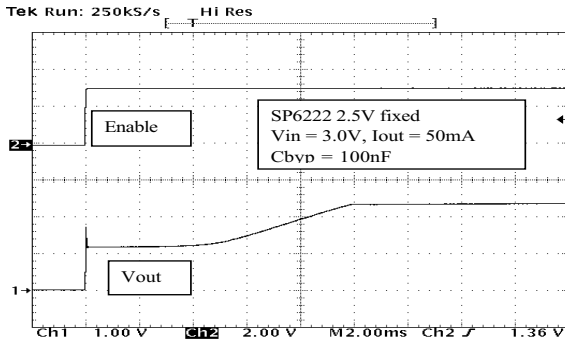

Turn on time, Vin = 3.0V, Iout = 50mA, CBYP = 100nF

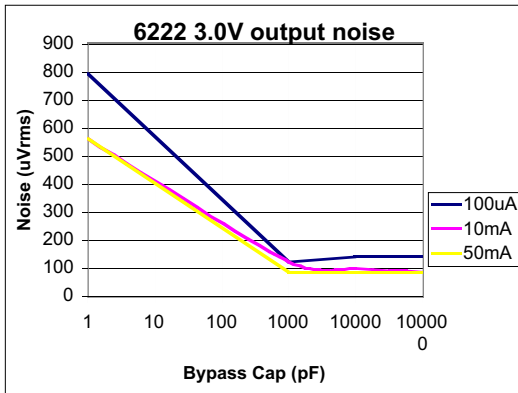

SP6222 3.0V Output Noise vs. CBYP

SP6222 3.0Vout PSRR 100uA, 4.5 Vin Cbyp-10nF

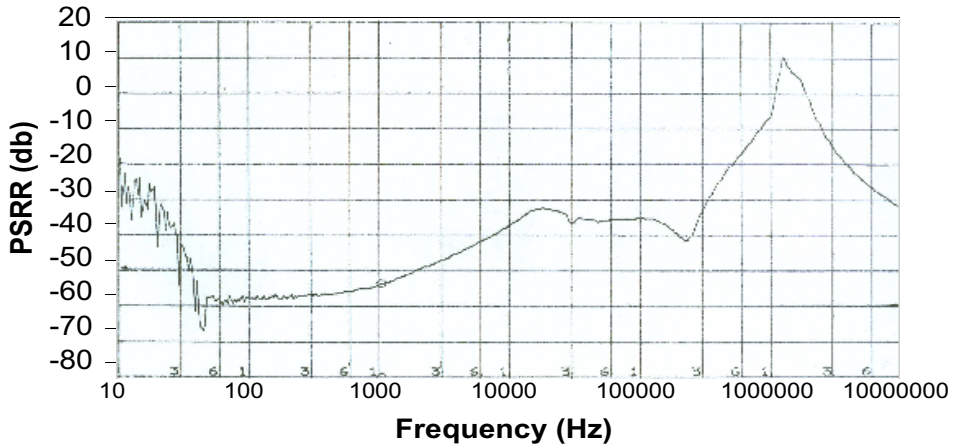

SP6222 3.0Vout PSRR 10mA, 4.5Vin, Cbyp-10nF

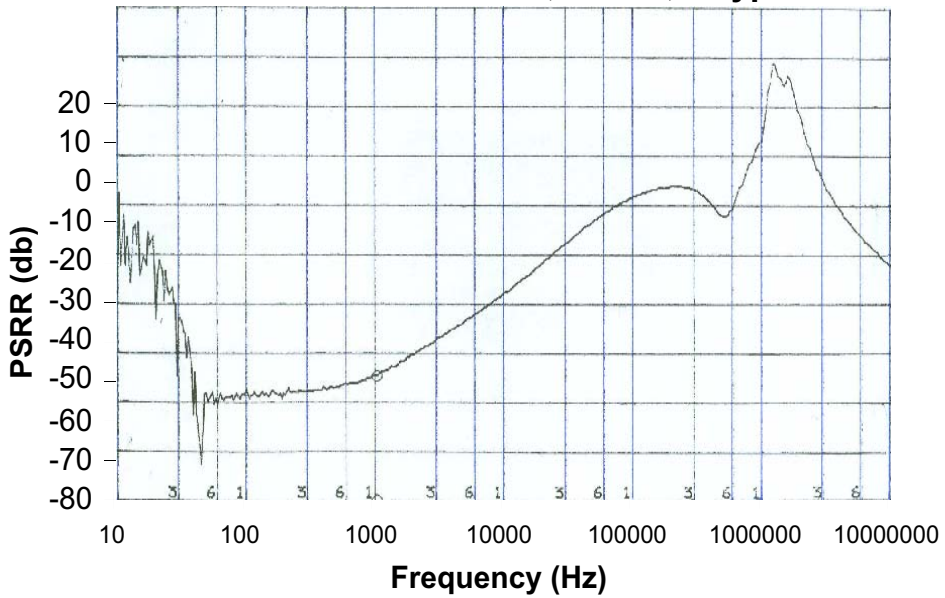

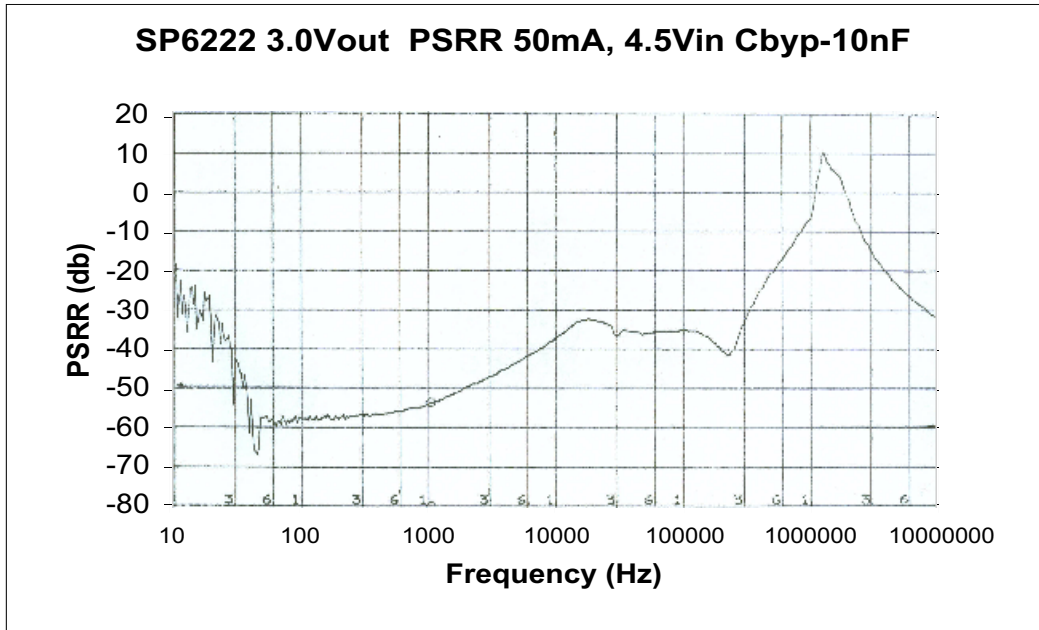

Typical Application Circuit for Adjustable Output

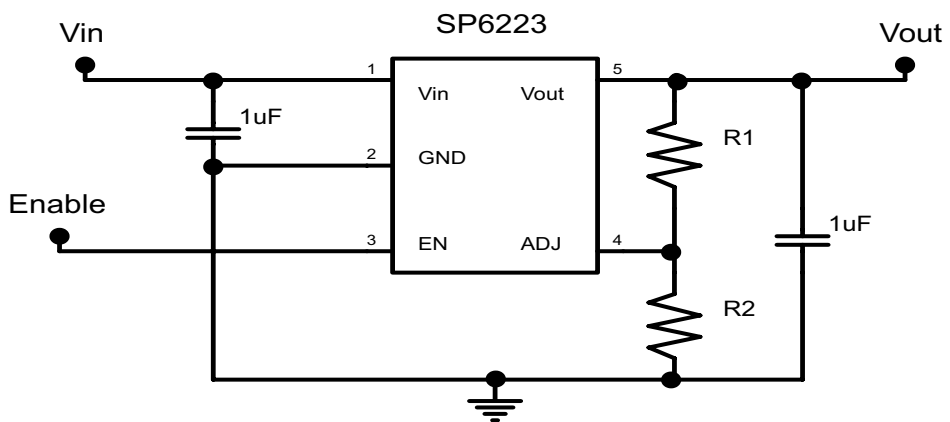

$$V_{OUT} = V_{REF} * [1 + (R1/R2)]$$

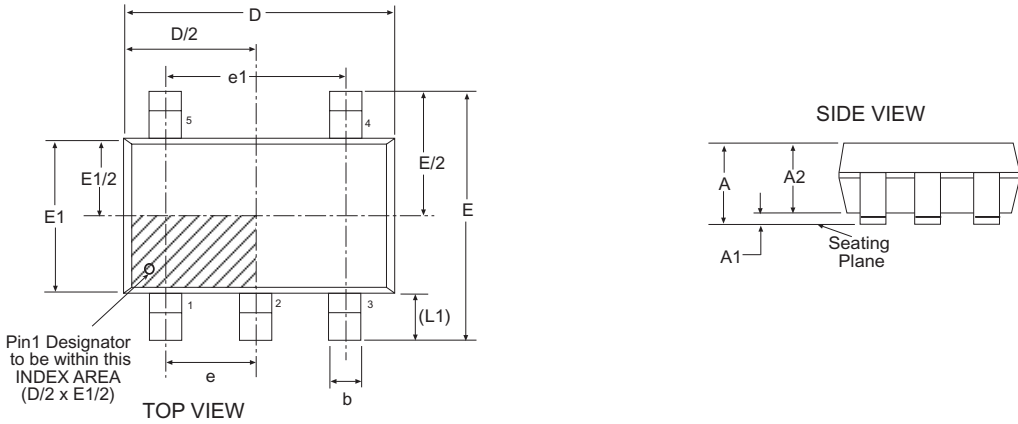

5 Pin SC-70		JEDEC MO-203		Variation AA		
SYMBOL	Dimensions in Millimeters: Controlling Dimension			Dimensions in Inches Conversion Factor: 1 Inch = 25.40 mm		
	MIN	NOM	MAX	MIN	NOM	MAX
A	-	-	1.10	-	-	0.043
A1	0.00	-	0.10	0.000	-	0.004
A2	0.70	0.90	1.00	0.028	0.036	0.039
c	0.08	-	0.22	0.004	-	0.009
D	2.00 BSC			0.079 BSC		
E	2.10 BSC			0.083 BSC		
E1	1.25 BSC			0.049 BSC		
L	0.26	0.36	0.46	0.011	0.014	0.018
L1	0.42 REF			0.017 REF		
L2	0.15 BSC			0.006 BSC		
R	0.10	-	-	0.004	-	-
R1	0.10	-	0.25	0.004	-	0.010
ϕ	0°	4°	8°	0°	4°	8°
$\phi 1$	4°	-	12°	4°	-	12°
b	0.15	-	0.30	0.006	-	0.012
e	0.65 BSC			0.026 BSC		
e1	1.30 BSC			0.051 BSC		
SIPEX Pkg Signoff Date/Rev:				JL Oct3-05 / Rev A		

Part Number	Temperature Range	Voltage Option	Package Type
SP6222EC5-2-5-L	-40°C to +125°C	2.5V	(Lead Free) 5 Pin SC70
SP6222EC5-2-5-L/TR	-40°C to +125°C	2.5V	(Lead Free) 5 Pin SC70
SP6222EC5-3-0-L	-40°C to +125°C	3.0V	(Lead Free) 5 Pin SC70
SP6222EC5-3-0-L/TR	-40°C to +125°C	3.0V	(Lead Free) 5 Pin SC70
SP6222EC5-L	-40°C to +125°C	ADJ	(Lead Free) 5 Pin SC70
SP6222EC5-L/TR	-40°C to +125°C	ADJ	(Lead Free) 5 Pin SC70
SP6222EK-2-5-L	-40°C to +125°C	2.5V	(Lead Free) 5 Pin SOT-23
SP6222EK-2-5-L/TR	-40°C to +125°C	2.5V	(Lead Free) 5 Pin SOT-23
SP6222EK-3-0-L	-40°C to +125°C	3.0V	(Lead Free) 5 Pin SOT-23
SP6222EK-3-0-L/TR	-40°C to +125°C	3.0V	(Lead Free) 5 Pin SOT-23
SP6222EK-L	-40°C to +125°C	ADJ	(Lead Free) 5 Pin SOT-23
SP6222EK-L/TR	-40°C to +125°C	ADJ	(Lead Free) 5 Pin SOT-23
SP6223EC5-L	-40°C to +125°C	ADJ	(Lead Free) 5 Pin SC70
SP6223EC5-L/TR	-40°C to +125°C	ADJ	(Lead Free) 5 Pin SC70
SP6223EK-L	-40°C to +125°C	ADJ	(Lead Free) 5 Pin SOT-23
SP6223EK-L/TR	-40°C to +125°C	ADJ	(Lead Free) 5 Pin SOT-23

Available in lead free packaging only.

/TR = Tape and Reel

Pack quantity is 3,000 for SC-70 and 2,500 for SOT-23.



Sipex Corporation

**Headquarters and
Sales Office**
233 South Hillview Drive
Milpitas, CA 95035
TEL: (408) 934-7500
FAX: (408) 935-7600

Sipex Corporation reserves the right to make changes to any products described herein. Sipex does not assume any liability arising out of the application or use of any product or circuit described herein; neither does it convey any license under its patent rights nor the rights of others.